



### 3 OFF-BOARD ELECTRONIC DRIVERS - only for A

Drivers model	E-MI-AC-01F		E-MI-AS-IR		E-BM-AS-PS		E-BM-AES
Type	Analog		Digital				
Voltage supply (VDC)	12	24	12	24	12	24	24
Valve coil option	/6	std	/6	std	/6	std	std
Format	plug-in to solenoid				DIN-rail panel		
Tech table	G010		G020		G030		GS050

### 4 GENERAL NOTES

Atos digital proportionals valves are CE marked according to the applicable directives (e.g. Immunity and Emission EMC Directive). Installation, wirings and start-up procedures must be performed according to the general prescriptions shown in tech table **FS900** and in the user manuals included in the E-SW-\* programming software.

### 5 VALVE SETTINGS AND PROGRAMMING TOOLS

Valve's functional parameters and configurations, can be easily set and optimized using Atos E-SW programming software connected via USB port to the digital driver. For fieldbus versions, the software permits valve's parameterization through USB port also if the driver is connected to the central machine unit via fieldbus.

The software is available in different versions according to the driver's options (see table **GS500**):

**E-SW-BASIC** support: NP (USB) PS (Serial) IR (Infrared)  
**E-SW-FIELDBUS** support: BC (CANopen) BP (PROFIBUS DP) EH (EtherCAT)  
EW (POWERLINK) EI (EtherNet/IP) EP (PROFINET)  
**E-SW-\*/PQ** support: valves with SP, SF, SL alternated control (e.g. E-SW-BASIC/PQ)



**WARNING: drivers USB port is not isolated!** For E-C-SB-USB/M12 cable, the use of isolator adapter is highly recommended for PC protection



**WARNING:** see tech table **GS500** for the list of countries where the Bluetooth adapter has been approved

### USB or Bluetooth connection

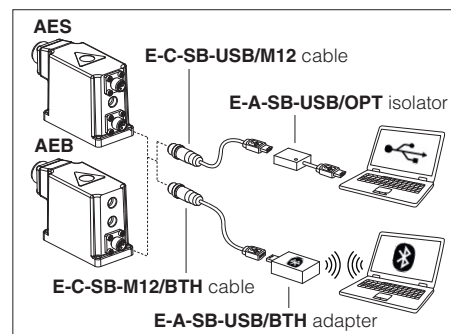

### 6 FIELDBUS - only for AES, see tech. table **GS510**

Fieldbus allows valve direct communication with machine control unit for digital reference, valve diagnostics and settings. These execution allow to operate the valves through fieldbus or analog signals available on the main connector.

### 7 GENERAL CHARACTERISTICS

Assembly position	Any position
Subplate surface finishing to ISO 4401	Acceptable roughness index: Ra ≤ 0,8, recommended Ra 0,4 – Flatness ratio 0,01/100
MTTFd valves according to EN ISO 13849	75 years, see technical table P007
Ambient temperature range	<b>A:</b> Standard = -20°C ÷ +70°C /PE option = -20°C ÷ +70°C /BT option = -40°C ÷ +60°C <b>AEB, AES:</b> Standard = -20°C ÷ +60°C /PE option = -20°C ÷ +60°C /BT option = -40°C ÷ +60°C
Storage temperature range	<b>A:</b> Standard = -20°C ÷ +80°C /PE option = -20°C ÷ +80°C /BT option = -40°C ÷ +70°C <b>AEB, AES:</b> Standard = -20°C ÷ +70°C /PE option = -20°C ÷ +70°C /BT option = -40°C ÷ +70°C
Surface protection	Zinc coating with black passivation, galvanic treatment (driver housing for AEB and AES)
Corrosion resistance	Salt spray test (EN ISO 9227) > 200 h
Compliance	CE according to EMC directive 2014/30/EU (Immunity: EN 61000-6-2; Emission: EN 61000-6-3) RoHS Directive 2011/65/EU as last update by 2015/863/EU REACH Regulation (EC) n°1907/2006

### 8 HYDRAULIC CHARACTERISTICS - based on mineral oil ISO VG 46 at 50 °C

Valve model	AGMZO-*-10	AGMZO-*-20	AGMZO-*-32
Max regulated pressure [bar]	50; 100; 210; 315; 350		
Max pressure at port P [bar]	350		
Max pressure at port T [bar]	210		
Min regulated pressure [bar]	see min. pressure / flow diagrams at section 11		
Max flow [l/min]	200	400	600
Response time 0-100% step signal (depending on installation) (1) [ms]	≤ 120	≤ 135	≤ 150
Hysteresis	≤ 0,5 [% of max pressure]		
Linearity	≤ 1,0 [% of max pressure]		
Repeatability	≤ 0,2 [% of max pressure]		

**Note:** above performance data refer to valves coupled with Atos electronic drivers, see section 3

(1) Average response time value; the pressure variation in consequence of a modification of the reference input signal to the valve is affected by the stiffness of the hydraulic circuit: greater is the stiffness of the circuit, faster is the dynamic response.

**9 ELECTRICAL CHARACTERISTICS**

Power supplies	Nominal : +24 VDC Rectified and filtered : VRMS = 20 ÷ 32 VMAX (ripple max 10 % VPP)			
Max power consumption	<b>A</b> = 30 W <b>AEB, AES</b> = 50 W			
Coil voltage code	standard	option /6	option /18	
Max. solenoid current	2,6 A	3,25 A	1,5 A	
Coil resistance R at 20°C	3 ÷ 3,3 Ω	2 ÷ 2,2 Ω	13 ÷ 13,4 Ω	
Analog input signals	Voltage: range ±10 VDC (24 VMAX tollerant) Current: range ±20 mA		Input impedance: Ri > 50 kΩ Input impedance: Ri = 500 Ω	
Monitor output	Output range: voltage ±5 VDC @ max 5 mA			
Enable input	Range: 0 ÷ 9 VDC (OFF state), 15 ÷ 24 VDC (ON state), 9 ÷ 15 VDC (not accepted); Input impedance: Ri > 87 kΩ			
Fault output	Output range : 0 ÷ 24 VDC (ON state ≡ VL+ [logic power supply] ; OFF state ≡ 0 V) @ max 50 mA; external negative voltage not allowed (e.g. due to inductive loads)			
Alarms	Solenoid not connected/short circuit, cable break with current reference signal, over/under temperature, current control monitoring, power supplies level, pressure transducer failure (/W option)			
Insulation class	H (180°) Due to the occurring surface temperatures of the solenoid coils, the European standards ISO 13732-1 and EN982 must be taken into account			
Protection degree to DIN EN60529	<b>A</b> = IP65; <b>AEB, AES</b> = IP66 / IP67 with mating connectors			
Duty factor	Continuous rating (ED=100%)			
Tropicalization	Tropical coating on electronics PCB			
Additional characteristics	Short circuit protection of solenoid's current supply; current control by P.I.D. with rapid solenoid switching; protection against reverse polarity of power supply			
Communication interface	USB Atos ASCII coding	CANopen EN50325-4 + DS408	PROFIBUS DP EN50170-2/IEC61158	EtherCAT EC 61158
Communication physical layer	not insulated USB 2.0 + USB OTG	optical insulated CAN ISO11898	optical insulated RS485	Fast Ethernet, insulated 100 Base TX
Recommended wiring cable	LiYCY shielded cables, see section 20			

**Note:** a maximum time of 500 ms (depending on communication type) have be considered between the driver energizing with the 24 Vdc power supply and when the valve is ready to operate. During this time the current to the valve coils is switched to zero.

**10 SEALS AND HYDRAULIC FLUIDS** - for other fluids not included in below table, consult our technical office

Seals, recommended fluid temperature	NBR seals (standard) = -20°C ÷ +60°C (+80°C for <b>A</b> ), with HFC hydraulic fluids = -20°C ÷ +50°C FKM seals (/PE option) = -20°C ÷ +80°C HNBR seals (/BT option) = -40°C ÷ +60°C, with HFC hydraulic fluids = -40°C ÷ +50°C		
Recommended viscosity	20 ÷ 100 mm <sup>2</sup> /s - max allowed range 15 ÷ 380 mm <sup>2</sup> /s		
Max fluid contamination level	normal operation	ISO4406 class 18/16/13 NAS1638 class 7	see also filter section at
	longer life	ISO4406 class 16/14/11 NAS1638 class 5	www.atos.com or KTF catalog
<b>Hydraulic fluid</b>	<b>Suitable seals type</b>	<b>Classification</b>	<b>Ref. Standard</b>
Mineral oils	NBR, FKM, HNBR	HL, HLP, HLPD, HVLP, HVLPD	DIN 51524
Flame resistant without water	FKM	HFDU, HFDR	ISO 12922
Flame resistant with water	NBR, HNBR	HFC	

**11 DIAGRAMS** (based on mineral oil ISO VG 46 at 50 °C)

**1 = Regulation diagrams**  
with flow rate Q = 50 l/min

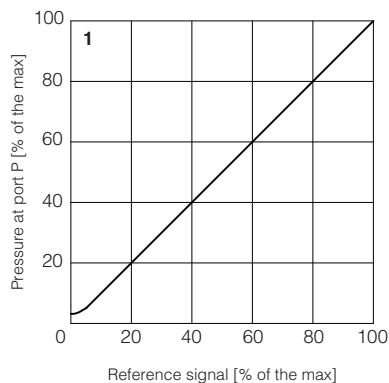

**2 = Pressure/flow diagrams**  
with reference signal set at Q = 50 l/min

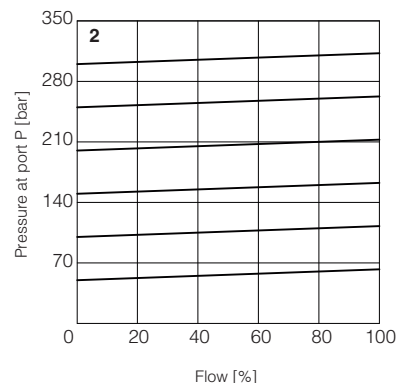

**3-8 = Min. pressure/flow diagrams**  
with zero reference signal

- 3 = AGMZO-\*-10/50, 100, 210, 315
- 4 = AGMZO-\*-10/350
- 5 = AGMZO-\*-20/50, 100, 210, 315
- 6 = AGMZO-\*-20/350
- 7 = AGMZO-\*-32/50, 100, 210, 315
- 8 = AGMZO-\*-32/350

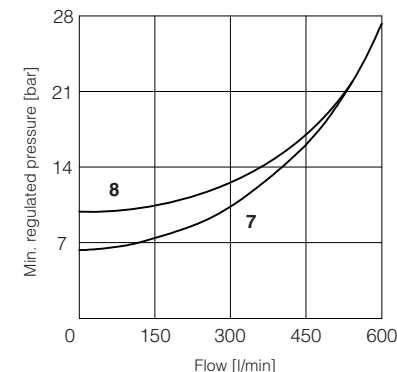
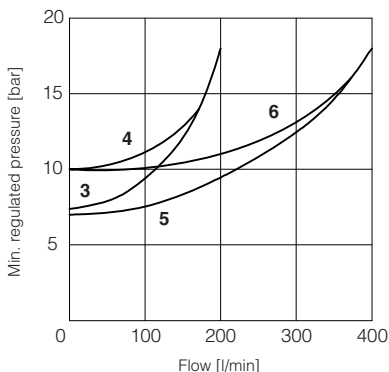

**12 HYDRAULIC OPTIONS**

- E** = External pilot option to be selected when the pilot pressure is supplied from a different line respect to the P main line. With option E the internal connection between port P and X of the valve is plugged. The pilot pressure must be connected to the X port available on the valve's mounting surface or on main body (threaded pipe connection G 1/4").
- Y** = The external drain is mandatory in case the main line T is subjected to pressure peaks or it is pressurized. The Y drain port has a threaded connection G 1/4" available on the pilot stage body.

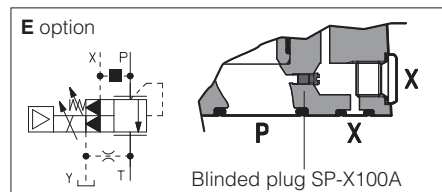

**13 ELECTRONICS OPTIONS** - only for **AEB** and **AES**

- I** = This option provides 4 ÷ 20 mA current reference and monitor signals, instead of the standard 0 ÷ 10 VDC. Input signal can be reconfigured via software selecting between voltage and current, within a maximum range of ±10 VDC or ±20 mA. It is normally used in case of long distance between the machine control unit and the valve or where the reference signal can be affected by electrical noise; the valve functioning is disabled in case of reference signal cable breakage.
- Q** = This option permits to inhibit the valve function without removing the power supply to the driver. Upon disable command the current to the solenoid is zeroed and the valve's spool moves to rest position. The option /Q is suggested for all cases where the valve has to be frequently inhibited during the machine cycle – see 18.5 for signal specifications.
- Z** = This option provides, on the 12 pin main connector, the following additional features:  
**Fault output signal** - see 18.6  
**Enable input signal** - see above option /Q  
**Power supply for driver's logics and communication** - see 18.2

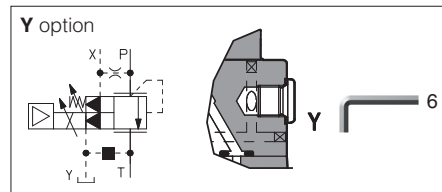

**14 POSSIBLE COMBINED OPTIONS**

- Hydraulic options:** all combination possible
- Electronics options:** /IQ, /IZ

**15 MECHANICAL PRESSURE LIMITER**

The AGMZO are provided with mechanical pressure limiter acting as protection against overpressure. For safety reasons the factory setting of the mechanical pressure limiter is fully unloaded (min pressure). At the first commissioning it must be set at a value lightly higher than the max pressure regulated with the proportional control. For the pressure setting of the mechanical pressure limiter, proceed according to following steps:

- apply the max reference input signal to the valve's driver. The system pressure will not increase until the mechanical pressure limiter remains unloaded.
- turn clockwise the adjustment screw ① until the system pressure will increase up to a stable value corresponding to the pressure setpoint at max reference input signal.
- turn clockwise the adjustment screw ① of additional 1 or 2 turns to ensure that the mechanical pressure limiter remains closed during the proportional valve working.

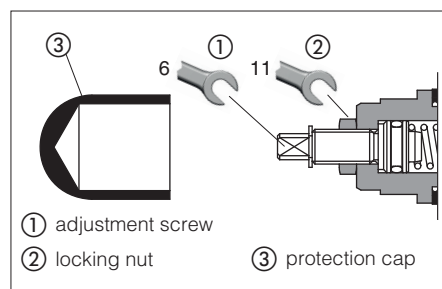

## 16 REMOTE PRESSURE UNLOADING

The **P** main line can be remotely unloaded by connecting the valve X port to a solenoid valve as shown in the below scheme (venting valve). This function can be used in emergency to unload the system pressure by-passing the proportional control.

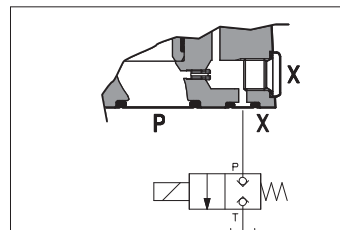

## 17 AIR BLEEDING

At the first valve commissioning the air eventually trapped inside the solenoid must be bled-off through the screw ① located at the rear side of the solenoid housing. The presence of air may cause pressure instability and vibrations.

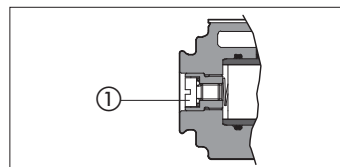

## 18 POWER SUPPLY AND SIGNALS SPECIFICATIONS - only for AEB and AES

Generic electrical output signals of the valve (e.g. fault or monitor signals) must not be directly used to activate safety functions, like to switch-ON/OFF the machine's safety components, as prescribed by the European standards (Safety requirements of fluid technology systems and components-hydraulics, ISO 4413).

### 18.1 Power supply (V+ and V0)

The power supply must be appropriately stabilized or rectified and filtered: apply at least a 10000  $\mu\text{F}/40\text{ V}$  capacitance to single phase rectifiers or a 4700  $\mu\text{F}/40\text{ V}$  capacitance to three phase rectifiers. In case of separate power supply see 18.2.



A safety fuse is required in series to each power supply: 2,5 A time lag fuse.

### 18.2 Power supply for driver's logic and communication (VL+ and VL0) - only for /Z option

The power supply for driver's logic and communication must be appropriately stabilized or rectified and filtered: apply at least a 10000  $\mu\text{F}/40\text{ V}$  capacitance to single phase rectifiers or a 4700  $\mu\text{F}/40\text{ V}$  capacitance to three phase rectifiers.

The separate power supply for driver's logic on pin 9 and 10, allow to remove solenoid power supply from pin 1 and 2 maintaining active the diagnostics, USB and fieldbus communications.



A safety fuse is required in series to each driver's logic and communication power supply: 500 mA fast fuse.

### 18.3 Reference input signal (INPUT+)

The driver controls in closed loop the current to the valve proportionally to the external reference input signal.

Reference input signal is factory preset according to selected valve code, defaults are  $0 \div 10\text{ V}_{\text{DC}}$  for standard and  $4 \div 20\text{ mA}$  for /I option.

Input signal can be reconfigured via software selecting between voltage and current, within a maximum range of  $\pm 10\text{ V}_{\text{DC}}$  or  $\pm 20\text{ mA}$ .

Drivers with fieldbus interface (BC, BP, EH) can be software set to receive reference signal directly from the machine control unit (fieldbus reference). Analog reference input signal can be used as on-off commands with input range  $0 \div 24\text{V}_{\text{DC}}$ .

### 18.4 Monitor output signal (MONITOR)

The driver generates an analog output signal (MONITOR) proportional to the actual coil current of the valve; the monitor output signal can be software set to show other signals available in the driver (e.g. analog reference, fieldbus reference).

Monitor output signal is factory preset according to selected valve code, default settings is  $0 \div 5\text{ V}_{\text{DC}}$  ( $1\text{ V} = 1\text{ A}$ ).

Output signal can be reconfigured via software, within a maximum range of  $\pm 5\text{ V}_{\text{DC}}$ .

### 18.5 Enable input signal (ENABLE) - not for standard

To enable the driver, supply a  $24\text{ V}_{\text{DC}}$  on pin 3 (pin C): Enable input signal allows to enable/disable the current supply to the solenoid, without removing the electrical power supply to the driver; it is used to active the communication and the other driver functions when the valve must be disabled for safety reasons. This condition **does not comply** with norms IEC 61508 and ISO 13849.

Enable input signal can be used as generic digital input by software selection.

### 18.6 Fault output signal (FAULT) - only for /Z option

Fault output signal indicates fault conditions of the driver (solenoid short circuits/not connected, reference signal broken for  $4 \div 20\text{ mA}$  input, etc.).

Fault presence corresponds to  $0\text{ V}_{\text{DC}}$ , normal working corresponds to  $24\text{ V}_{\text{DC}}$ .

Fault status is not affected by the Enable input signal.

## 19 ELECTRONIC CONNECTIONS

### 19.1 Main connector signals - 7 pin (A1) Standard and /Q option - for AEB and AES

PIN	Standard	/Q	TECHNICAL SPECIFICATIONS	NOTES
A	V+		Power supply 24 Vdc	Input - power supply
B	V0		Power supply 0 Vdc	Gnd - power supply
C	AGND		Analog ground	Gnd - analog signal
		ENABLE	Enable (24 Vdc) or disable (0 Vdc) the driver, referred to V0	Input - on/off signal
D	INPUT+		Reference input signal: $\pm 10$ Vdc / $\pm 20$ mA maximum range Defaults are 0 ÷ 10 Vdc for standard and 4 ÷ 20 mA for /I option	Input - analog signal <b>Software selectable</b>
E	INPUT-		Negative reference input signal for INPUT+	Input - analog signal
F	MONITOR referred to: AGND   V0		Monitor output signal: $\pm 5$ Vdc maximum range Default is 0 ÷ 5 Vdc (1V = 1A)	Output - analog signal <b>Software selectable</b>
G	EARTH		Internally connected to driver housing	

### 19.2 Main connector signals - 12 pin (A2) /Z option - for AEB and AES

PIN	/Z	TECHNICAL SPECIFICATIONS	NOTES
1	V+	Power supply 24 Vdc	Input - power supply
2	V0	Power supply 0 Vdc	Gnd - power supply
3	ENABLE	Enable (24 Vdc) or disable (0 Vdc) the driver, referred to VL0	Input - on/off signal
4	INPUT+	Reference input signal: $\pm 10$ Vdc / $\pm 20$ mA maximum range Defaults are 0 ÷ 10 Vdc for standard and 4 ÷ 20 mA for /I option	Input - analog signal <b>Software selectable</b>
5	INPUT-	Negative reference input signal for INPUT+	Input - analog signal
6	MONITOR	Monitor output signal: $\pm 5$ Vdc maximum range, referred to VL0 Default is 0 ÷ 5 Vdc (1V = 1A)	Output - analog signal <b>Software selectable</b>
7	NC	Do not connect	
8	NC	Do not connect	
9	VL+	Power supply 24 Vdc for driver's logic and communication	Input - power supply
10	VL0	Power supply 0 Vdc for driver's logic and communication	Gnd - power supply
11	FAULT	Fault (0 Vdc) or normal working (24 Vdc), referred to VL0	Output - on/off signal
PE	EARTH	Internally connected to driver housing	

**Note:** do not disconnect VL0 before VL+ when the driver is connected to PC USB port

### 19.3 Communication connectors - for AEB (B) and AES (B) - (C)

(B) USB connector - M12 - 5 pin always present		
PIN	SIGNAL	TECHNICAL SPECIFICATION (1)
1	+5V_USB	Power supply
2	ID	Identification
3	GND_USB	Signal zero data line
4	D-	Data line -
5	D+	Data line +

(C1) BC fieldbus execution, connector - M12 - 5 pin (2)		
PIN	SIGNAL	TECHNICAL SPECIFICATION (1)
1	CAN_SHLD	Shield
2	NC	do not connect
3	CAN_GND	Signal zero data line
4	CAN_H	Bus line (high)
5	CAN_L	Bus line (low)

(C2) BP fieldbus execution, connector - M12 - 5 pin (2)		
PIN	SIGNAL	TECHNICAL SPECIFICATION (1)
1	+5V	Termination supply signal
2	LINE-A	Bus line (high)
3	DGND	Data line and termination signal zero
4	LINE-B	Bus line (low)
5	SHIELD	

(C3) (C4) EH fieldbus execution, connector - M12 - 4 pin (2)		
PIN	SIGNAL	TECHNICAL SPECIFICATION (1)
1	TX+	Transmitter
2	RX+	Receiver
3	TX-	Transmitter
4	RX-	Receiver
Housing	SHIELD	

(1) Shield connection on connector's housing is recommended

(2) Only for AES execution

### 19.4 Solenoid connection - only for A

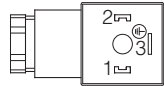
PIN	SIGNAL	TECHNICAL SPECIFICATION	Connector code 666
1	COIL	Power supply	
2	COIL	Power supply	
3	GND	Ground	

## 19.5 AEB connections layout

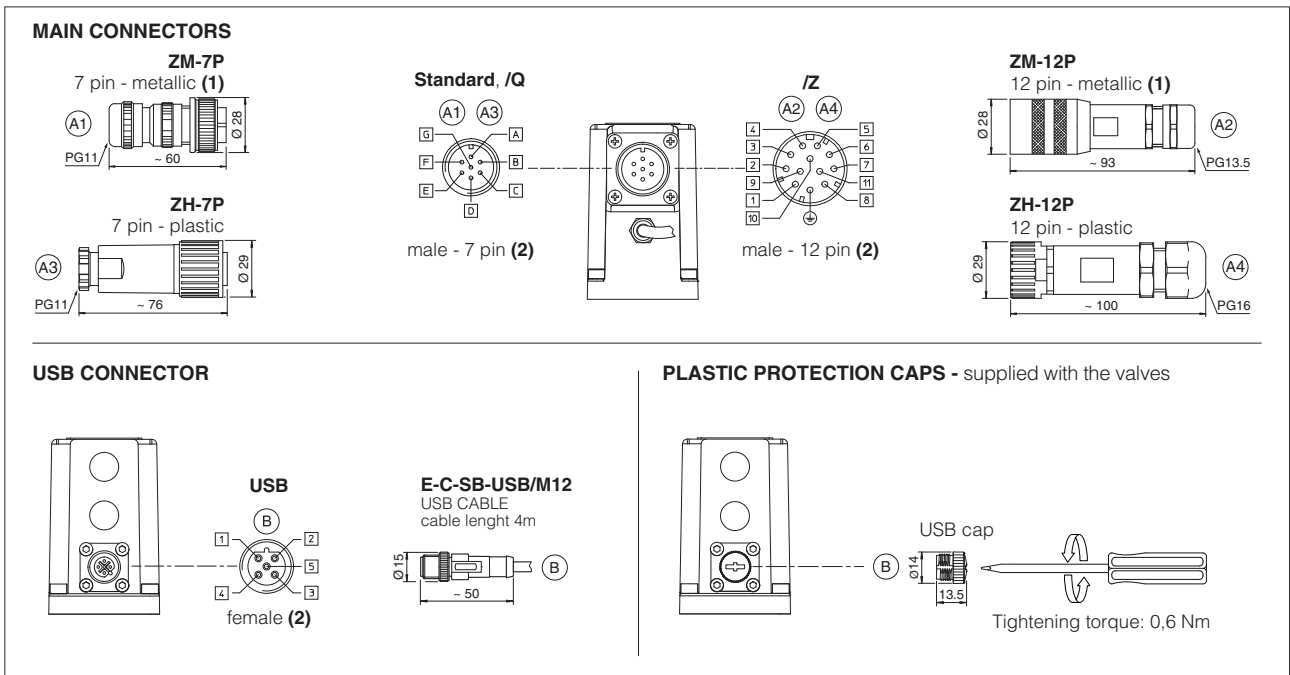

(1) Use of metallic connectors is strongly recommended in order to fulfill EMC requirements (2) Pin layout always referred to driver's view

## 19.6 AES connections layout

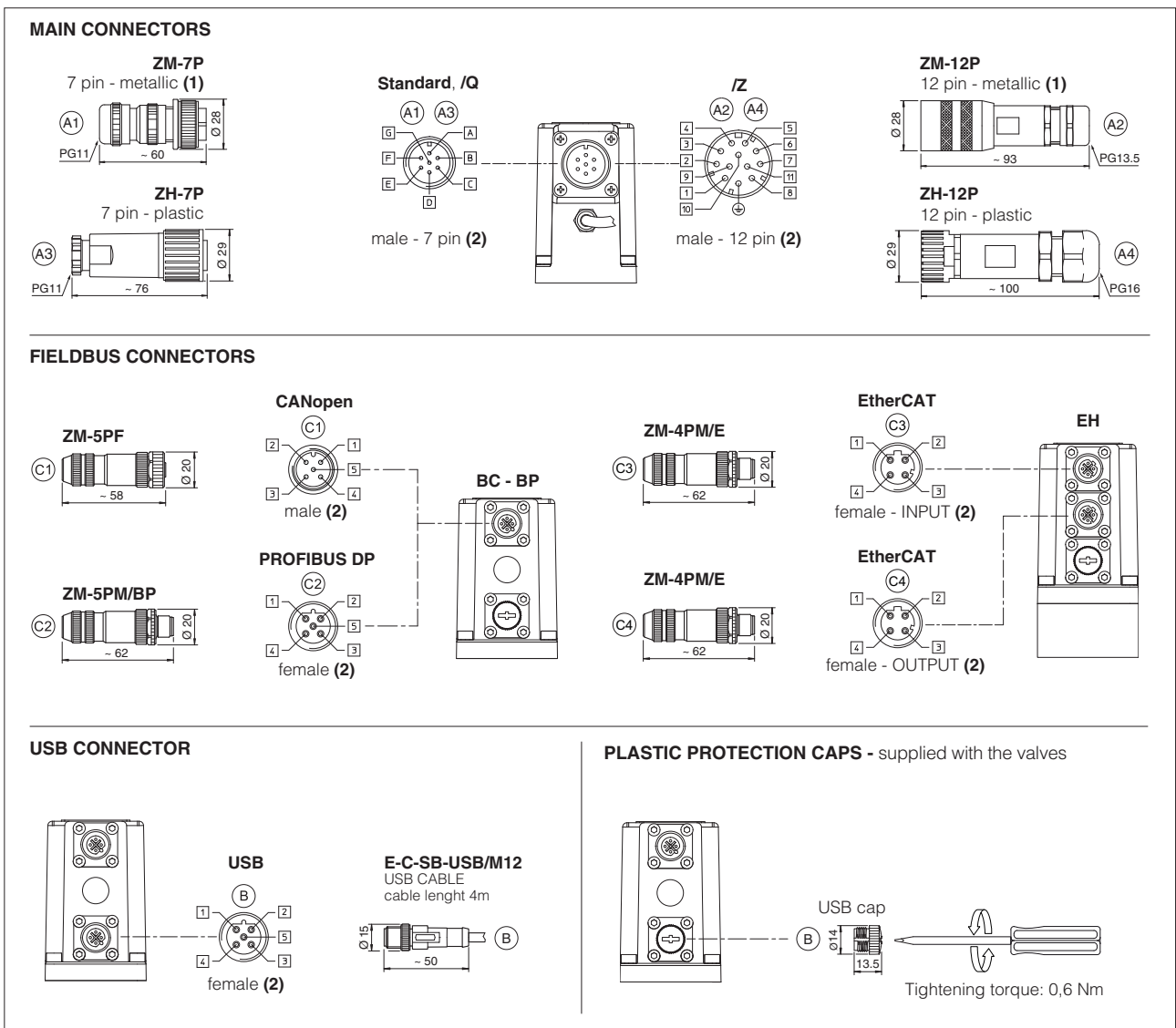

(1) Use of metallic connectors is strongly recommended in order to fulfill EMC requirements (2) Pin layout always referred to driver's view



**20 CONNECTORS CHARACTERISTICS** - to be ordered separately

**20.1 Main connectors - 7 pin - for AEB and AES**

CONNECTOR TYPE	POWER SUPPLY	POWER SUPPLY
<b>CODE</b>	<b>(A1) ZM-7P</b>	<b>(A3) ZH-7P</b>
Type	7pin female straight circular	7pin female straight circular
Standard	According to MIL-C-5015	According to MIL-C-5015
Material	Metallic	Plastic reinforced with fiber glass
Cable gland	PG11	PG11
Recommended cable	LiYCY 7 x 0,75 mm <sup>2</sup> max 20 m (logic and power supply) or LiYCY 7 x 1 mm <sup>2</sup> max 40 m (logic and power supply)	LiYCY 7 x 0,75 mm <sup>2</sup> max 20 m (logic and power supply) or LiYCY 7 x 1 mm <sup>2</sup> max 40 m (logic and power supply)
Conductor size	up to 1 mm <sup>2</sup> - available for 7 wires	up to 1 mm <sup>2</sup> - available for 7 wires
Connection type	to solder	to solder
Protection (EN 60529)	IP 67	IP 67

**20.2 Main connectors - 12 pin - for AEB and AES**

CONNECTOR TYPE	POWER SUPPLY	POWER SUPPLY
<b>CODE</b>	<b>(A2) ZM-12P</b>	<b>(A4) ZH-12P</b>
Type	12pin female straight circular	12pin female straight circular
Standard	DIN 43651	DIN 43651
Material	Metallic	Plastic reinforced with fiber glass
Cable gland	PG13,5	PG16
Recommended cable	LiYCY 12 x 0,75 mm <sup>2</sup> max 20 m (logic and power supply)	LiYCY 10 x 0,14mm <sup>2</sup> max 40 m (logic) LiYY 3 x 1mm <sup>2</sup> max 40 m (power supply)
Conductor size	0,5 mm <sup>2</sup> to 1,5 mm <sup>2</sup> - available for 12 wires	0,14 mm <sup>2</sup> to 0,5 mm <sup>2</sup> - available for 9 wires 0,5 mm <sup>2</sup> to 1,5 mm <sup>2</sup> - available for 3 wires
Connection type	to crimp	to crimp
Protection (EN 60529)	IP 67	IP 67



**20.3 Fieldbus communication connectors - only for AES**

CONNECTOR TYPE	BC CANopen (1)		BP PROFIBUS DP (1)		EH EtherCAT (2)	
<b>CODE</b>	<b>(C1) ZM-5PF</b>	<b>(C2) ZM-5PM</b>	<b>(C1) ZM-5PF/BP</b>	<b>(C2) ZM-5PM/BP</b>	<b>(C1) (C2) ZM-4PM/E</b>	
Type	5 pin female straight circular	5 pin male straight circular	5 pin female straight circular	5 pin male straight circular	4 pin male straight circular	
Standard	M12 coding A – IEC 61076-2-101		M12 coding B – IEC 61076-2-101		M12 coding D – IEC 61076-2-101	
Material	Metallic		Metallic		Metallic	
Cable gland	Pressure nut - cable diameter 6÷8 mm		Pressure nut - cable diameter 6÷8 mm		Pressure nut - cable diameter 4÷8 mm	
Cable	CANbus Standard (DR 303-1)		PROFIBUS DP Standard		Ethernet standard CAT-5	
Connection type	screw terminal		screw terminal		terminal block	
Protection (EN 60529)	IP67		IP 67		IP 67	

**(1)** E-TRM-\*\* terminators can be ordered separately - see tech table **GS500**

**(2)** Internally terminated

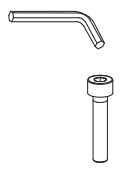
**21 FASTENING BOLTS AND SEALS**

	<b>AGMZO-*-10</b>	<b>AGMZO-*-20</b>	<b>AGMZO-*-32</b>
	<b>Fastening bolts:</b> 4 socket head screws M12x35 class 12.9 Tightening torque = 125 Nm	<b>Fastening bolts:</b> 4 socket head screws M16x50 class 12.9 Tightening torque = 300 Nm	<b>Fastening bolts:</b> 4 socket head screws M20x60 class 12.9 Tightening torque = 600 Nm
	<b>Seals:</b> 2 OR 123 Diameter of ports P, T: Ø 14 mm 1 OR 109/70 Diameter of port X: Ø 3,2 mm	<b>Seals:</b> 2 OR 4112 Diameter of ports P, T: Ø 24 mm 1 OR 109/70 Diameter of port X: Ø 3,2 mm	<b>Seals:</b> 2 OR 4131 Diameter of ports P, T: Ø 28 mm 1 OR 109/70 Diameter of port X: Ø 3,2 mm





## SIZE 32

ISO 6264: 2007

Mounting surface: 6264-10-17-1-97

(see table P005)

(with M20 fixing holes instead of standard M18)

	Mass [kg]		
	A	AEB, AES	AES-EH
AGMZO-*-32	8,0	8,5	8,6

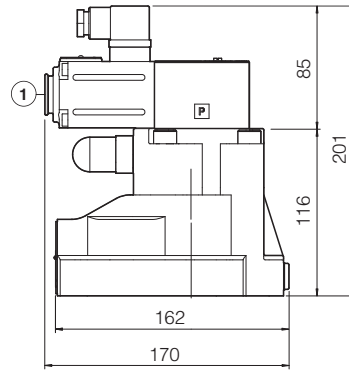

AGMZO-A-32

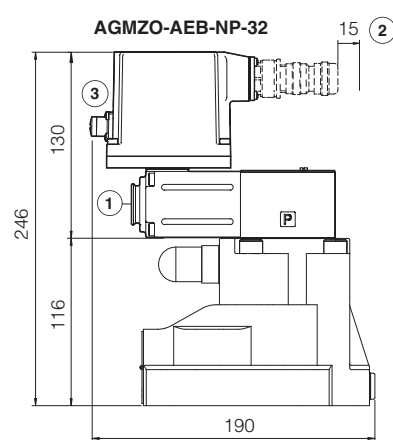
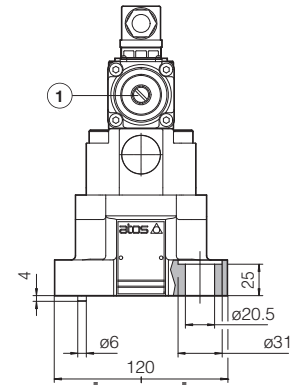

AGMZO-AEB-NP-32

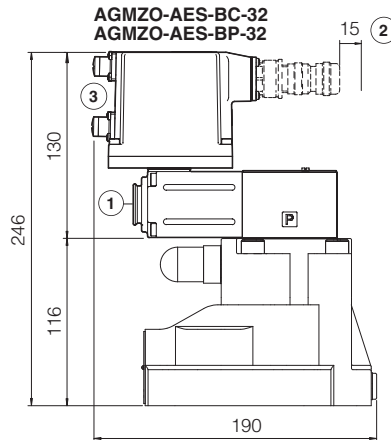

AGMZO-AES-BC-32  
AGMZO-AES-BP-32

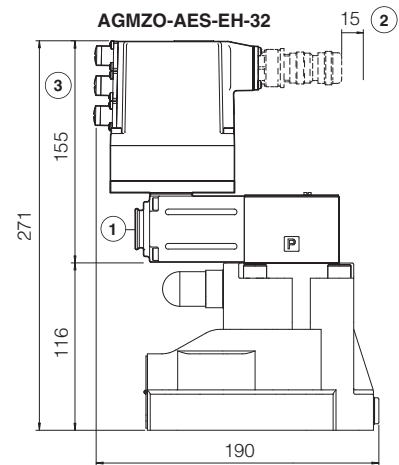

AGMZO-AES-EH-32

① = Air bleeding, see section 17 

② = Space to remove the connectors

③ = The dimensions of all connectors must be considered, see section 19.5 and 19.6

## 23 RELATED DOCUMENTATION

<b>FS001</b>	Basics for digital electrohydraulics	<b>GS500</b>	Programming tools
<b>FS900</b>	Operating and maintenance information for proportional valves	<b>GS510</b>	Fieldbus
<b>G010</b>	E-MI-AC analog driver	<b>K800</b>	Electric and electronic connectors
<b>G020</b>	E-MI-AS-IR digital driver	<b>P005</b>	Mounting surfaces for electrohydraulic valves
<b>G030</b>	E-BM-AS digital driver	<b>QB200</b>	Quickstart for AEB valves commissioning
<b>GS050</b>	E-BM-AES digital driver	<b>QF200</b>	Quickstart for AES valves commissioning